

PAYA LEBAR METHODIST GIRLS' SCHOOL (PRIMARY)

2025 END-OF-YEAR EXAMINATION

PRIMARY FOUR

MATHEMATICS

Paper 1

Name : _____ ()

Class : Primary 4 _____

Date : 30 October 2025

Total Time for Sections A, B and C: 1 hour 45 minutes

INSTRUCTIONS TO CANDIDATES

1. Do not turn over this page until you are told to do so.
2. Follow all instructions carefully.
3. Answer all questions.
4. Use a 2B pencil to shade your answers on the Optical Answer Sheet (OAS).
5. All the figures in this paper are **not drawn to scale** unless stated otherwise.
6. This paper consists of 8 printed pages.

	Marks Obtained / Maximum Marks	
SECTION A	/	32
SECTION B and SECTION C	/	68
TOTAL	/	100

PARENT'S SIGNATURE: _____

Questions 1 to 16 carry 2 marks each. For each question, four options are given. One of them is the correct answer. Make your choice (1, 2, 3 or 4). Shade the correct oval (1, 2, 3 or 4) on the Optical Answer Sheet. (32 marks)

1. The value of the digit 2 in 42 513 is _____.

(1) 20

(2) 200

(3) 2000

(4) 20 000

()

2. In 57.92, the digit _____ is in the tenths place.

(1) 9

(2) 2

(3) 7

(4) 5

()

3. Which of the following is not an equivalent fraction of $\frac{1}{4}$?

(1) $\frac{3}{12}$

(2) $\frac{4}{16}$

(3) $\frac{6}{24}$

(4) $\frac{7}{32}$

()

4. 2 and 3 are factors of _____.

- (1) 10
- (2) 18
- (3) 27
- (4) 29

()

5. $6\frac{3}{8} = \frac{\boxed{}}{8}$

What is the missing number in the box?

- (1) 51
- (2) 48
- (3) 26
- (4) 18

()

6. Write $7\frac{9}{25}$ as a decimal.

- (1) 7.9
- (2) 7.09
- (3) 7.36
- (4) 7.036

()

Use the information below to answer questions 7 and 8.

The table below shows the number of burgers and muffins sold by Mr Loh for 5 days.

	Number of Burgers Sold	Number of Muffins Sold
Monday	25	30
Tuesday	24	24
Wednesday	28	27
Thursday	30	22
Friday	26	21

7. How many more burgers than muffins were sold on Thursday?

- (1) 1
- (2) 5
- (3) 3
- (4) 8

()

8. On which two days did Mr Loh sell the same total number of burgers and muffins?

- (1) Monday and Wednesday
- (2) Monday and Friday
- (3) Tuesday and Wednesday
- (4) Tuesday and Friday

()

9. Which of the following figures is a net of a cuboid?

(1)

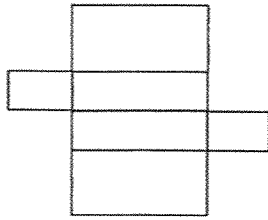

(2)

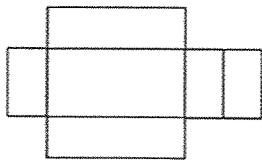

(3)

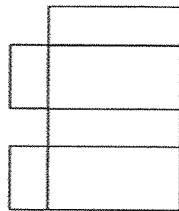

(4)

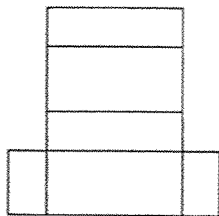

()

10. Valerie mixed 17.82ℓ of water and 5.18ℓ of orange syrup to make some orange juice. She poured the orange juice equally into 8 similar jugs. How much orange juice did she pour into each jug? Round your answer to the nearest tenth.

(1) 2.8ℓ

(2) 2.9ℓ

(3) 2.87ℓ

(4) 2.88ℓ

()

11. Amy took $\frac{7}{12}$ h to fix a jigsaw puzzle. Jenny took $\frac{2}{3}$ h slower to fix the same jigsaw puzzle.

How long did Jenny take to fix the puzzle?

Express your answer in the simplest form.

(1) $\frac{1}{12}$ h

(2) $\frac{3}{5}$ h

(3) $1\frac{1}{4}$ h

(4) $1\frac{5}{6}$ h

()

12. The figure shown is a garden made up of 2 square plots, Plot X and Plot Y.

The total area of the garden is 52 m^2 . The area of Plot Y is 16 m^2 .

What is the length of Plot X?

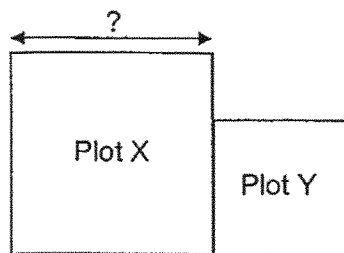

(1) 36 m

(2) 24 m

(3) 6 m

(4) 4 m

()

13. The pie chart below shows the different ways 162 students go to school.

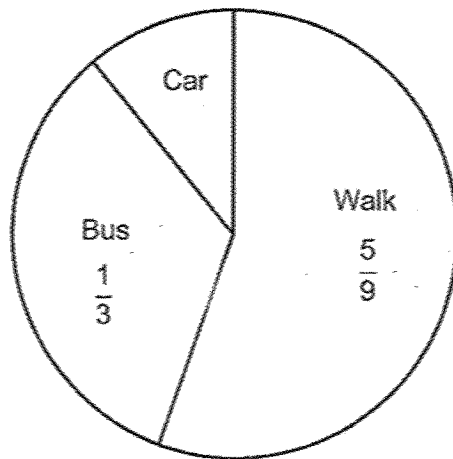

How many students go to school by car?

- (1) 6
- (2) 18
- (3) 36
- (4) 54

()

14. The perimeter of the rectangle shown below is 42 cm. What is the length of the rectangle?

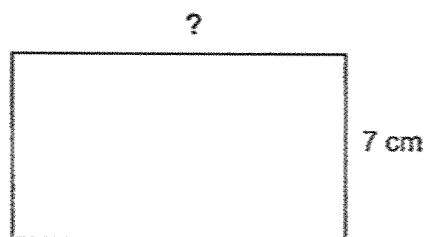

- (1) 28 cm
- (2) 21 cm
- (3) 14 cm
- (4) 6 cm

()

15. Which of the following letters has at least one line of symmetry?

(1)

G

(2)

C

(3)

N

(4)

K

()

16. Bala is arranging stickers on a display board. He has more than 20 stickers but fewer than 50 stickers. When he arranges them in rows of 6, there are 4 stickers left over. When he arranges them in rows of 8, there are 2 stickers left over. How many stickers does Bala have?

(1) 48

(2) 40

(3) 34

(4) 24

()

End of Booklet A

PAYA LEBAR METHODIST GIRLS' SCHOOL (PRIMARY)

2025 END-OF-YEAR EXAMINATION

PRIMARY FOUR

MATHEMATICS

Paper 2

Name : _____ ()

Class : Primary 4 _____

Date : 30 October 2025

Total Time for Sections A, B and C: 1 hour 45 minutes

INSTRUCTIONS TO CANDIDATES

1. Do not turn over this page until you are told to do so.
2. Follow all instructions carefully.
3. Answer all questions.
4. All the figures in this paper are **not drawn to scale** unless stated otherwise.
5. This paper consists of **18** printed pages.

	Marks Obtained / Maximum Marks	
SECTION B	/	40
SECTION C	/	28
TOTAL	/	68

SECTION B

Questions 17 to 36 carry 2 marks each. Write your answers in the spaces provided. For questions which require units, give your answers in the units stated.

(40 marks)

Do not write in this space

17. Write twenty thousand and forty-one in numerals.

Ans: _____

18. Arrange these fractions from the smallest to the greatest.

$$\frac{8}{11}, \frac{1}{2}, \frac{5}{11}$$

Ans: _____, _____, _____
(smallest) (greatest)

19. Round 18 430 to the nearest hundred.

Ans: _____

20. Rectangle PQRS is made up of 8 unit squares.
What fraction of rectangle PQRS is shaded?

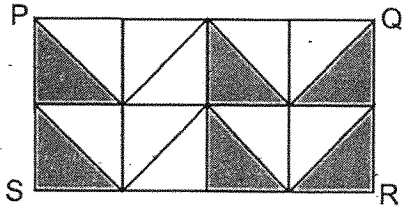

Do not
write in
this
space

Ans: _____

21. Express 0.6 as a fraction.

Ans: _____

22. Name the two angles that are smaller than 90° .

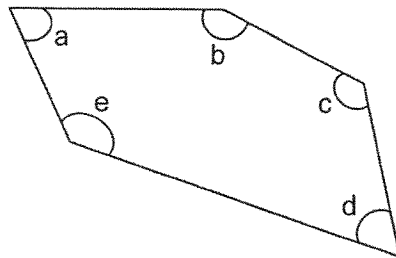

Ans: \angle ___ and \angle ___

23. What is the remainder when 2503 is divided by 4?

Do not write in this space

Ans: _____

24. Write the decimal represented by A.

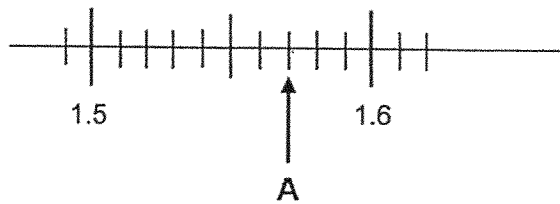

Ans: _____

25. ABCD is a rectangle. Find $\angle x$.

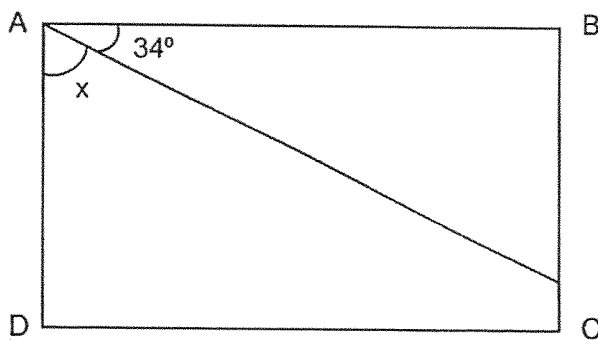

Ans: _____^o

26. Complete the drawing of Square WXYZ and label Point Z.

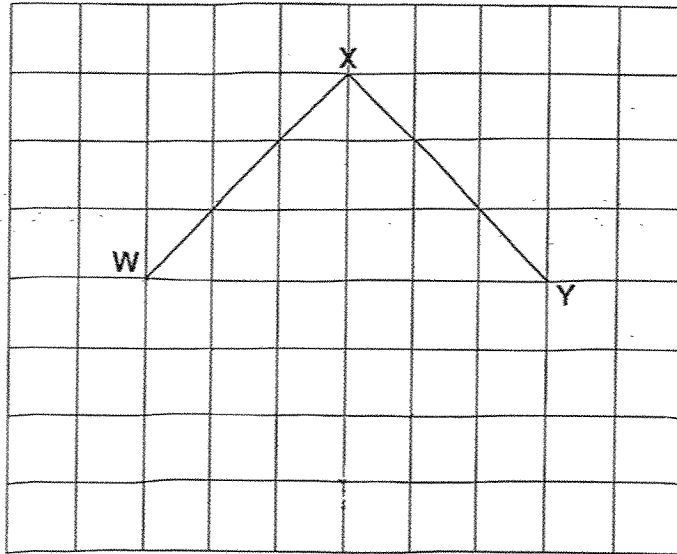

Do not write in this space



27. Janice bought a roll of ribbon, 3 m long, to wrap some presents.
She cut the roll of ribbon into 7 equal pieces.
What is the length of each piece of ribbon?
Round your answer to the nearest hundredth.

Ans: _____ m



28. The bar graph shows the number of students who borrowed books from the school library from January to April.

Do not write in this space

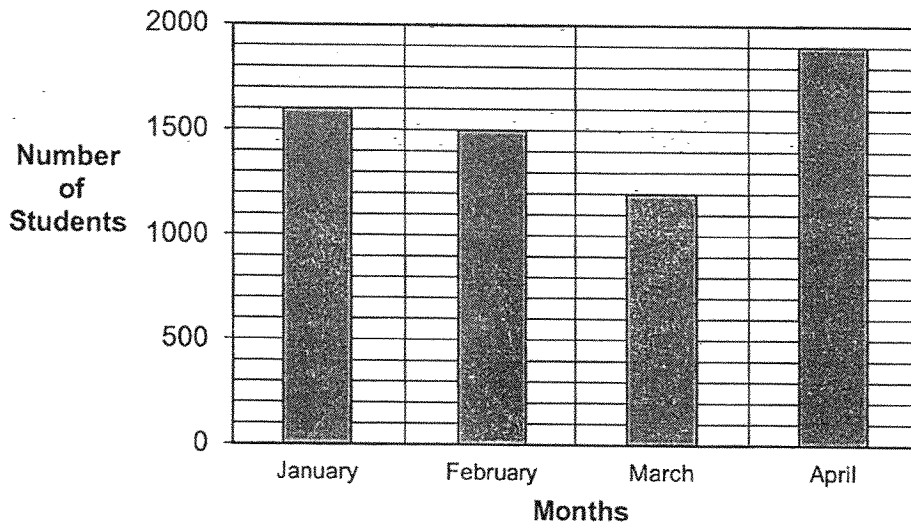

- a) In which month did the least number of students borrow books?

Ans: _____

- b) How many fewer students borrowed books in March than in April?

Ans: _____

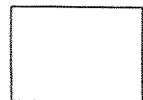

29. Gladys jogged a distance of $\frac{2}{3}$ km.

She jogged $\frac{1}{5}$ km more than the distance jogged by Ben.

What was the total distance Gladys and Ben jogged?

Give your answer as a mixed number.

Do not
write in
this
space

Ans: _____ km

30. Measure and write down the size of $\angle AOB$.

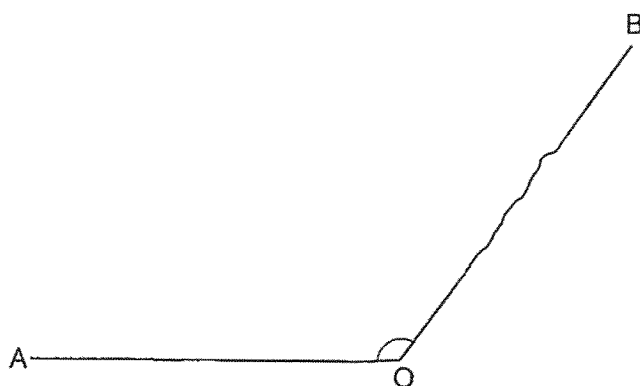

Ans: _____ °

31. In the figure, PQRS is a rectangle with an area of 144 cm^2 and $PS = 9 \text{ cm}$.
X and Y are identical squares. Find the length of one side of square Y.

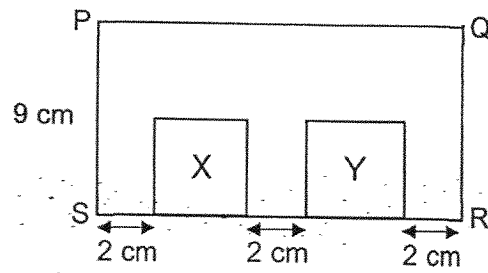

Do not
write in
this
space

Ans: _____ cm

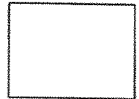

32. In the figure below, a rectangular piece of paper ABCD was folded along BD.
Find $\angle a$.

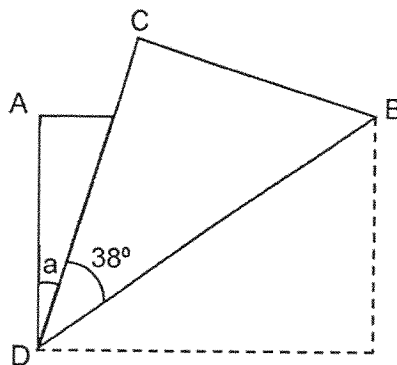

Ans: _____ °

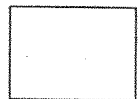

33. Figures J, K, L and M are geometric figures.

Do not
write in
this
space

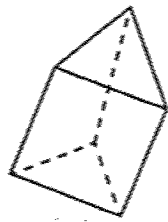

Figure J

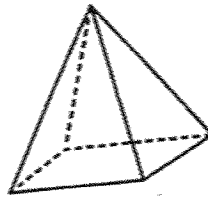

Figure K

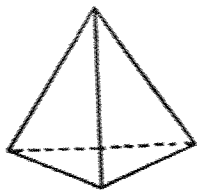

Figure L

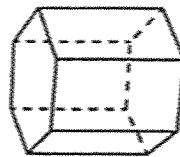
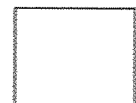

Figure M

Identify the geometric figures.

Write the letter representing the figure in the table below.

Geometric Figures	Figures
pyramid	Ans: (a) _____ and _____
prism	Ans: (b) _____ and _____



Use the information below to answer questions 34 and 35.

The line graph shows the number of customers in a restaurant at different times in a day.

Do not
write in
this
space

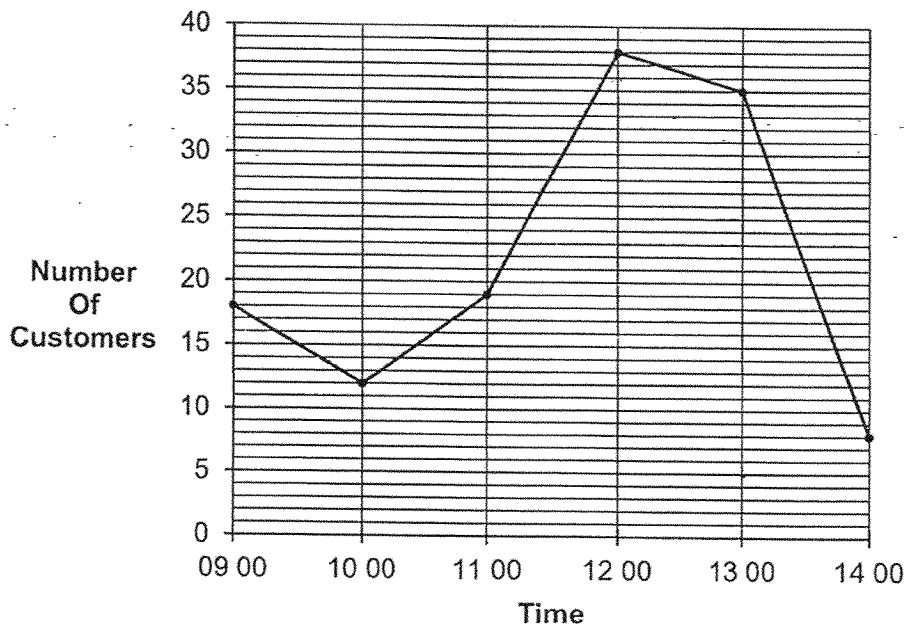

34. During which 1-hour interval was the increase in the number of customers in the restaurant the greatest?

Ans: _____ to _____

35. What was the decrease in the number of customers from 12 00 to 14 00?

Ans: _____

36. In the figure below, ABCD is made up of 7 identical rectangles. $BC = 27$ cm.
Find the perimeter of the figure.

Do not
write in
this
space

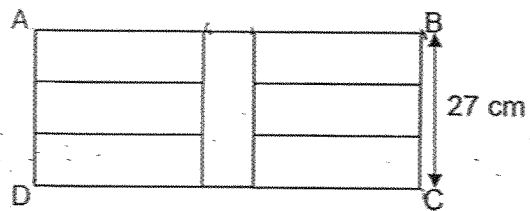

Ans: _____ cm



SECTION C

For questions 37 to 43, show your working clearly in the space provided for each question and write your answers in the spaces provided. The number of marks available is shown in brackets [] at the end of each question or part-question.

(28 marks)

Do not
write in
this
space

37. Weiling bought 24 packets of sweets. There were 32 sweets in each packet.
She gave 12 sweets to each of her 40 classmates.

(a) How many sweets did Weiling buy altogether?

Ans: (a) _____ [1]

(b) How many sweets were left?

Ans: (b) _____ [3]

38. Farid baked some cookies. He gave away $\frac{3}{10}$ of his cookies to his friends and gave away $\frac{1}{2}$ of his cookies to his siblings. He had 50 cookies left.

Do not
write in
this
space

(a) What fraction of Farid's cookies was left?

Ans: (a) _____ [1]

(b) How many cookies did Farid bake?

Ans: (b) _____ [3]

39. The figure below is made up of 3 rectangles, A, B and C, and Square D. Rectangle A and Rectangle B are identical. Rectangle B has a breadth of 5 cm. The area of Square D is 49 cm^2 .

Do not write in this space

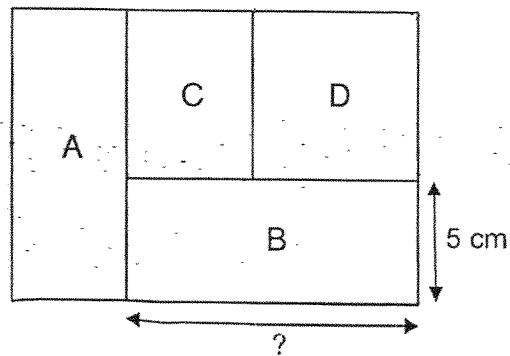

- (a) What is the length of Rectangle B?

Ans: (a) _____ [2]

- (b) What is the total area of the figure?

Ans: (b) _____ [2]



40. Siti used white squares and black dots to form figures that follow a pattern. The first four figures are shown below.

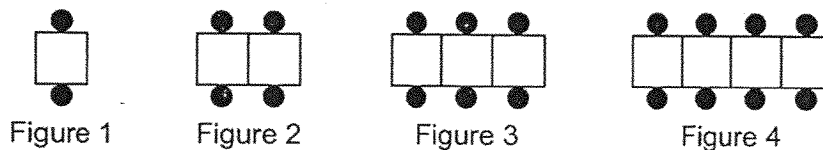

Do not write in this space

- (a) Complete the table below for Figure 5.

Figure Number	White Squares	Black Dots	Total number of white squares and black dots
1	1	2	3
2	2	4	6
3	3	6	9
4	4	8	12
5	5	(a) _____ [1]	(a) _____ [1]

- (b) What is the total number of white squares and black dots used to form Figure 24?

Ans: (b) _____ [2]

4

41. Sarah had twice as many blue beads as red beads. She had 3 times as many green beads as blue beads. She had a total of 1728 blue and green beads.

Do not
write in
this
space

(a) How many green beads did Sarah have?

Ans: (a) _____ [3]

(b) How many fewer red beads than green beads did Sarah have?

Ans: (b) _____ [1]

4

42. The total mass of 3 identical tables and 5 identical stools is 173.1 kg.
The total mass of 1 such table and 3 such stools is 65.3 kg.

Do not
write in
this
space

(a) What is the total mass of a table and a stool?

Ans: (a) _____ [2]

(b) What is the mass of 4 stools?

Ans: (b) _____ [2]

43. Andy has a rectangular piece of paper measuring 40 cm by 20 cm as shown in Figure 1. He cuts out a square from the paper and shifts it to the side of the piece of paper to create a new figure as shown in Figure 2. There is no overlapping of the 2 pieces of paper. Figure 2 has a perimeter of 160 cm.

Do not write in this space

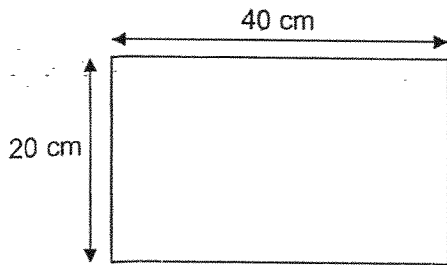

Figure 1

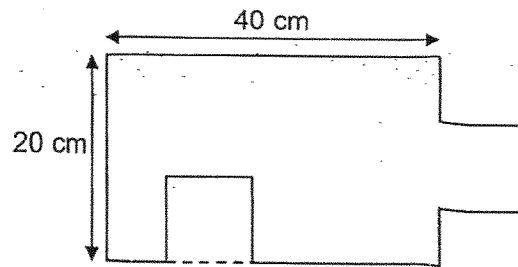

Figure 2

- (a) What is the perimeter of Figure 1?

Ans: (a) _____ [1]

- (b) What is the area of the square that was cut out?

Ans: (b) _____ [3]



End of Paper

SCHOOL : PAYA LEBAR MGS PRIMARY SCHOOL
LEVEL : PRIMARY 4
SUBJECT : MATHEMATICS
TERM : 2025 END OF YEAR EXAMINATION

Q1	Q2	Q3	Q4	Q5	Q6	Q7	Q8	Q9	Q10
3	1	4	2	1	3	4	1	4	2
Q11	Q12	Q13	Q14	Q15	Q16				
3	3	2	3	2	3				

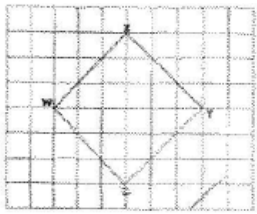
17)	20041
18)	$\frac{11}{11} = \frac{8}{11}$
19)	18400
20)	$\frac{3}{8}$
21)	$\frac{6}{10}$
22)	$< a$ and $< d$
23)	3
24)	1.57
25)	56°
26)	
27)	0.43 m
28)	a) March b) 700
29)	$1\frac{2}{15}$
30)	
31)	$10 \div 2 = 5$ cm
32)	14°

33)	a) K and L b) J and M
34)	1100 to 1200
35)	30
36)	$27 + 27 + 54 = 54$ $54 + 54 + 27 + 27 + 9 + 9 = \mathbf{180\text{ cm}}$
37)	a) $24 \times 32 = 768$ b) $12 \times 40 = 480$ $768 - 480 = \mathbf{288}$
38)	a) $\frac{1}{2} \times 5 = \frac{5}{10}$ $\frac{5}{10} + \frac{3}{10} = \frac{8}{10}$ $\frac{10}{10} - \frac{8}{10} = \frac{2}{10}$ b) $\frac{1}{10} \rightarrow 50 \div 2 = 25$ $\frac{10}{10} \rightarrow 25 \times 10 = \mathbf{250}$
39)	a) $7 \times 7 = 49$ $7 \times 5 = 12\text{ m}$ b) $12 + 5 = 17$ $17 \times 12 = \mathbf{204\text{ cm}^2}$
40)	a) 10, 15 b) $24 \times 2 = 48$ $48 + 24 = \mathbf{72}$
41)	a) $6 + 2 = 8$ $1728 \div 8 = 216$ $216 \times 6 = \mathbf{1296}$ b) $1\text{ u} \rightarrow 216$

42)	a) $173.1 - 65.3 = 107.8$ $107.8 \div 2 = 53.9 \text{ kg}$ b) $173.1 - 53.9 = 119.2$ $119.2 - 107.8 = 11.4$ $11.4 \rightarrow 2 \text{ stools}$ $4 \text{ stools} = 11.4 \times 2 = 22.8 \text{ kg}$
43)	a) $20 + 40 = 60$ $60 \times 2 = 120 \text{ cm}$ b) $160 - 120 = 40$ $40 \div 4 = 10$ $10 \times 10 = 100 \text{ cm}^2$

